

# TRIADE

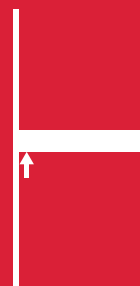

WOOD AND  
GLASS  
SHELVING  
SYSTEMS



# SYMBOLS AND FINISHES LEGEND

## SYMBOLS

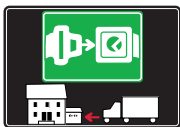

= SHELF SAFELY LOCKED DURING TRANSPORTATION AND AT HOME.



= ANTI-TURNOVER LOCKING SYSTEM



= NORMS / PATENTS



= PHILLIPS / POZIDRIV



= NEWTON



= PART.NO



= HEXAGONAL SOCKET



= FRICTION



= PCS. PER PACKAGE



= BLADE SLOT



= AUTOMATIC



= COMBI SLOT



= DROP DOWN



= CAPACITY LOADING



= COUNTERSUNK HEAD



= WOOD / GLASS THICKNESS



= PAN HEAD



= STANDARD HINGE



= HOLE DIAMETER



= FLANGE HEAD



= KIMANA HINGE



= DIAMETER



= FLAT HEAD



= FLAP HINGE



= LENGTH



= TRILOBULAR SCREW



= WITH SPRING



= HEIGHT



= SELF-TAPPING SCREW



= WITHOUT SPRING



= RIGHT VERSION



= EURO THREAD



= REVERSED SPRING



= LEFT VERSION



= METRIC THREAD



= SETTING CODE



= PRE-INSERTED SCREW



= FOR ROUND TUBE



= PCS. PER PAD



= PRE-INSERTED SCREW AND SPREADING BUSH



= FOR OVAL TUBE



= CUT ON REQUEST



= WITH BUFFER



= SELF ADHESIVE



= WITH MAGNET



= WITH FLANGE

NOTE: Printing errors and omissions may exist despite our best efforts to ensure accuracy. We reserve the right to alter specifications without notice.

## MATERIALS

<b>ZA</b> = Zinc Alloy	<b>ST</b> = Steel	<b>HSS</b> = High Speed Steel	<b>BR</b> = Brass	<b>ABS</b> = Acrylonitrile Butadiene Styrene
<b>ZAnk</b> = Nickel-plated Zinc Alloy	<b>STzk</b> = Zinc-plated Steel	<b>AL</b> = Aluminium	<b>WD</b> = Wood	<b>EVA</b> = Ethylene Vinyl Acetate

**EP** = **ENGINEERING PLASTIC**

+ **EP** = other engineering plastic available on request

**SR** = **SOFT RUBBER**

+ **SR** = other soft rubber available on request

<b>EPn</b> = Natural Engineering Plastic	<b>EPc</b> = Clear Engineering Plastic	<b>SRn</b> = Natural Soft Rubber
<b>EPw</b> = White Engineering Plastic	<b>EPg</b> = Grey Engineering Plastic	<b>SRw</b> = White Soft Rubber
<b>EPwg</b> = Water Green Engineering Plastic		<b>SRb</b> = Black Soft Rubber



## FINISHES



+ = OTHER FINISHES AVAILABLE ON REQUEST

PART. NO	FINISHES	PART. NO	FINISHES	PART. NO	FINISHES
AA	Natural	JB	Bright Aluminium	QB	Walnut
AB	White	JC	Aluminium - Chrome	RO	Red
AC	Opal White	JD	Matt Aluminium	UZ	T -Met
AE	White 9010	JE	Satin-finished Aluminium	WA	Bronzed
AK	Champagne	JF	Aluminium - Brass	WI	Burnished
AL	Ivory	JG	Aluminium 5	XD	Satin-finished Steel
EA	Black	JL	Aluminium PE 11	YA	Nickel-plated
EB	Glossy Black	JM	Aluminium RAL 9006	YB	Bright Nickel-plated
EC	Matt Black	KA	Chrome	YC	Matt Nickel-plated
EE	Anthracite	KB	Bright Chrome	YD	Satin-finished Nickel-plated
FU	Gunmetal	KC	Matt Chrome	ZA	Zinc alloy
GR	Raw	MA	Brown	ZN	Zinc-plated
HA	Brass-Plated	MB	Light Brown 1	ZQ	Bright Gold
HH	Tropicalized	NN	Metallic Beige	ZY	Titanium
HL	Raw Brass	NO	Beige	ZZ	Clear
IA	Grey	OA	Oak	00	Insignificant finish
IB	Metallic Grey	OZ	Ash		
IF	Middle Grey	PA	Light Ash		
IJ	Light Grey	PZ	Beech		
IL	Grey 20	QA	Maple		

## TRIADE

**TRIADE** is the concealed mounting bracket for shelves 25 to 40mm thick. It has been conceived to simplify the shelf installation. It is provided with three independent adjustments:

1) VERTICAL

Before installing the shelf, the mounting brackets can be adjusted in height and (vertically) aligned through the slots.

2) HORIZONTAL

While placing the shelf in position, the supporting pins can be slid horizontally.

3) INCLINATION

When the shelf is partially inserted, the shelf angle can be adjusted front to back by turning the supporting pins with a 10mm open-ended wrench.

The capacity loading is 15Kg each (shelf weight included) for a shelf max 300mm deep.

30-40 mm

15 kg for each shelf support for shelf 300 mm deep

PAT. PENDING

Shelf minimum depth: 160mm

Zinc alloy and steel

### INSTALLATION AND ADJUSTMENTS

#### WOOD PANEL

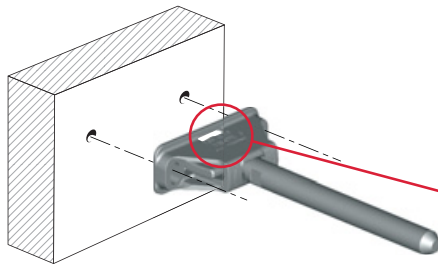

Recommended fixing pan head screw type - head Ø 5 mm max.

**VERY IMPORTANT**  
Triade has to be installed with the writing "TOP - ALTO" facing upwards.



#### SOLID AND PLASTERBOARD PANEL

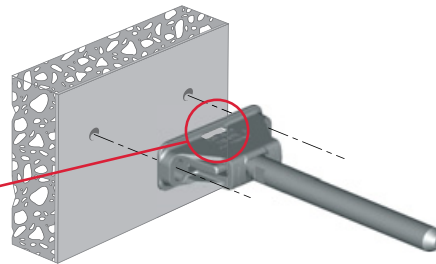

It is the responsibility of the customer:  
- to ensure the wall is of a suitable quality to hold the shelf fixing in place.  
- to use the proper hardware fittings according to the construction of the wall.

For more specific information, please refer to the WARNINGS section at the end of the catalogue.

#### BRACKET ALIGNMENT

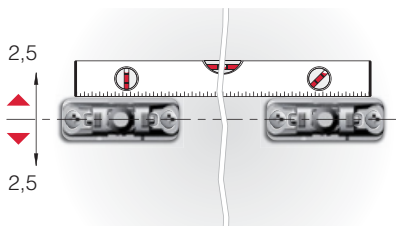

#### LATERAL ADJUSTMENT

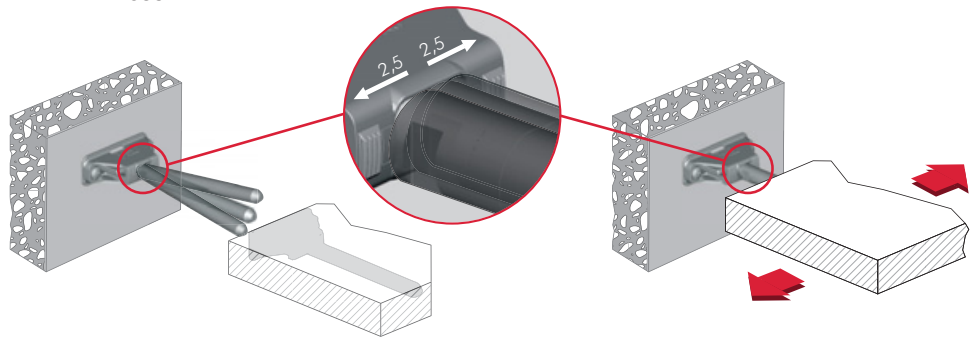

#### INCLINATION ADJUSTMENT

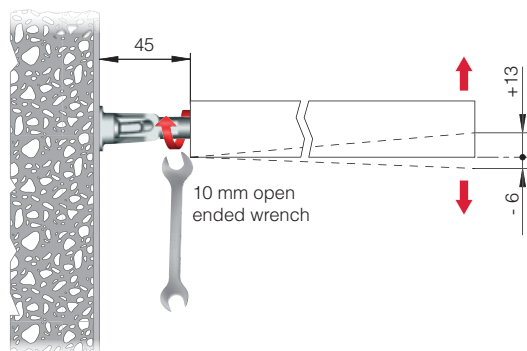

#### COMBINATION SHELF LOAD AND SHELF DEPTH

(The figures refer to 1 shelf support)

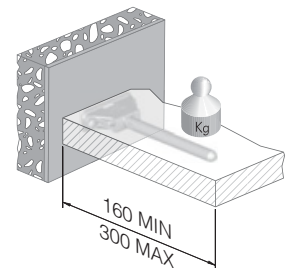
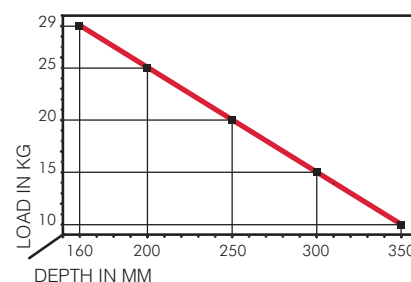

+ shelf weight = 15 kg MAX for each shelf support

For installation details refer to "APPLICATION FOR ALL TRIADE VERSIONS"

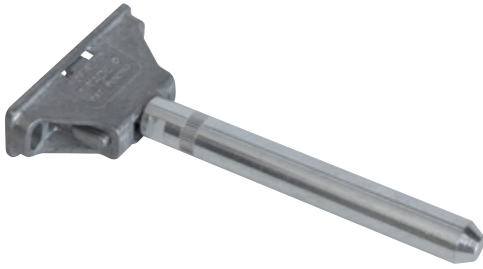

= PZ2	= open ended wrench 10 mm
	= 50 pcs.
123	
1621501000	

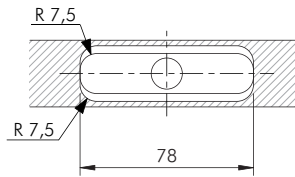
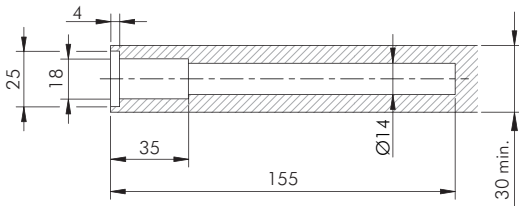
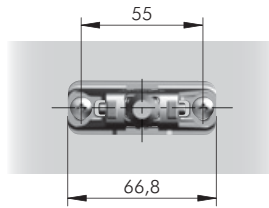
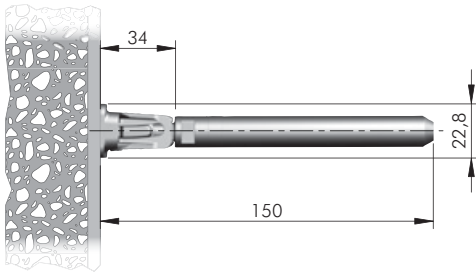

**DRILL BIT FOR TRIADE**

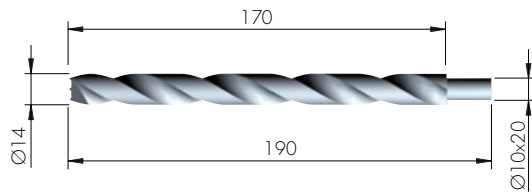
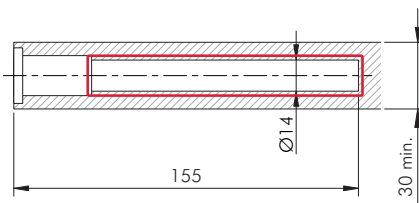

HSS	= on request
123	
1621452000	

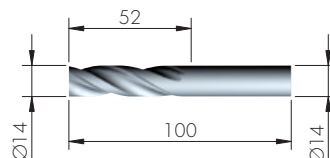
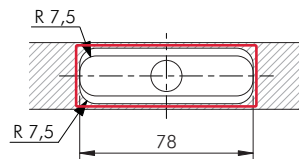
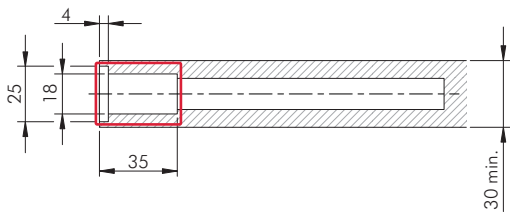

HSS	= on request
123	
1621454000	

## TRIADE AND BRACKET

### INSTALLATION

#### SOLID AND PLASTERBOARD PANEL

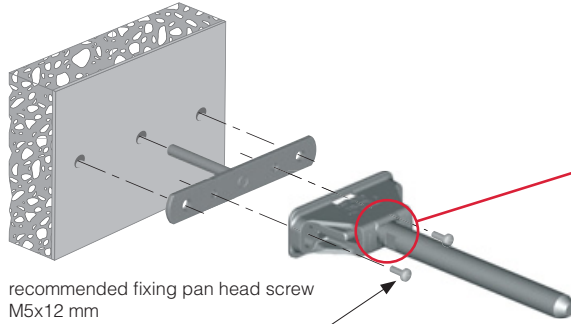

#### VERY IMPORTANT

Triade has to be installed with the writing "TOP - ALTO" facing upwards.



It is the responsibility of the customer:

- to ensure the wall is of a suitable quality to hold the shelf fixing in place.
- to use the proper hardware fittings according to the construction of the wall.

For more specific information, please refer to the WARNINGS section at the end of the catalogue.

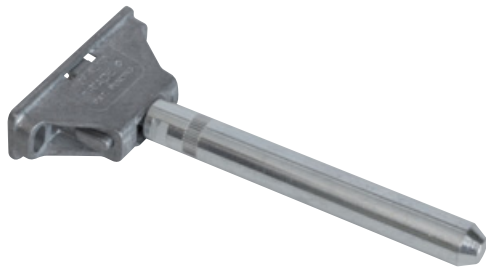

= PZ2	= open ended wrench 10 mm
ZA	ST
123	= 50 pcs.
1621501000	



= M5	= 100 pcs.
ST	
123	
16215020ZN	

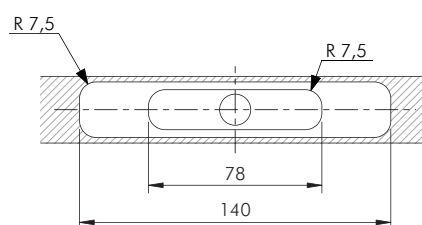
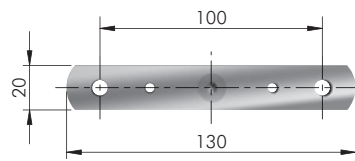
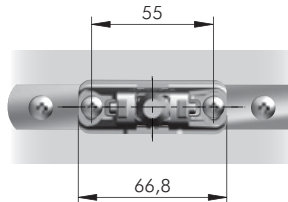
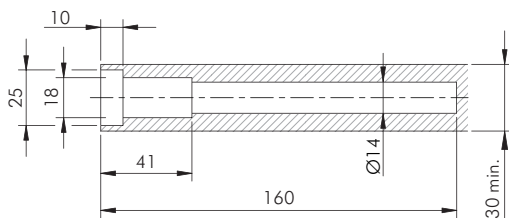
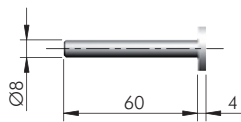
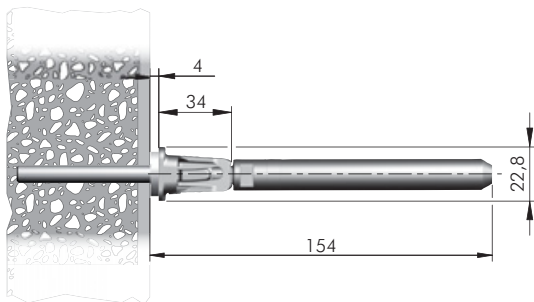



**TRIADE BRACKET FIXING ACCESSORY**

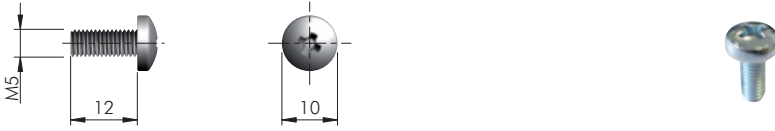

= M5	= PZ2	
		= 1000 pcs.
60334030ZN		

**DRILL BIT FOR TRIADE AND BRACKET**

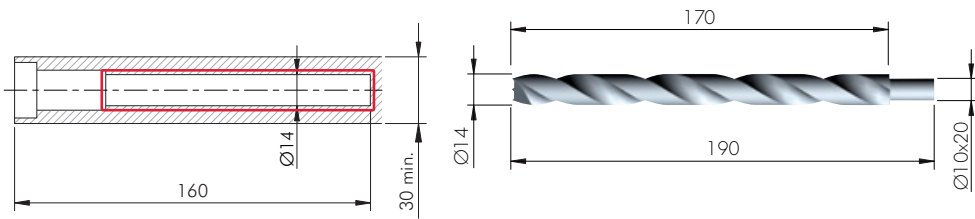

HSS	= on request
1621452000	

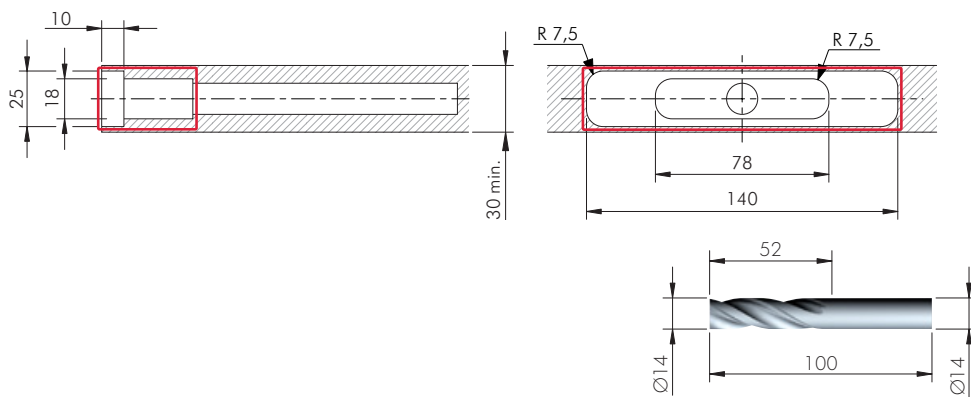

HSS	= on request
1621454000	

## APPLICATION FOR ALL TRIADE VERSIONS

### VERTICAL ADJUSTMENTS

RELEASE THE FIXING SCREWS

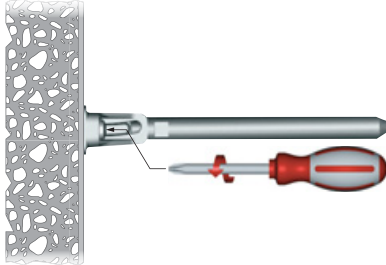

ALIGN BRACKETS VERTICALLY ACCORDINGLY

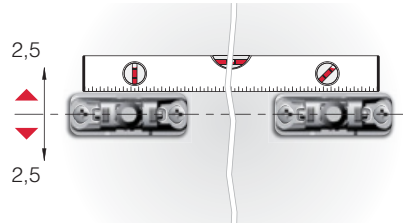

TIGHT THE FIXING SCREWS

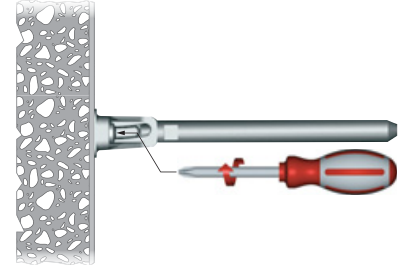

### SHELF INSERTING AND LATERAL ADJUSTMENT

TILT THE SHELF TO MATCH BOTH SUPPORTING PINS AND SHELF HOUSINGS

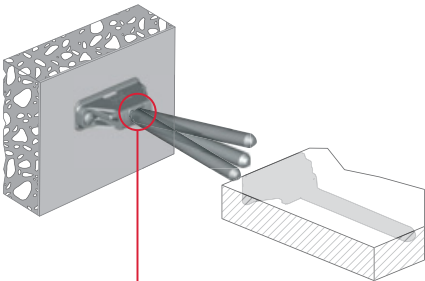

INSERT PARTIALLY THE SHELF

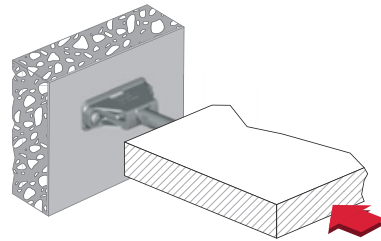

ADJUST THE SHELF Laterally ACCORDING TO THE APPLICATION (i.e. MULTI-SHELF COMPOSITION)

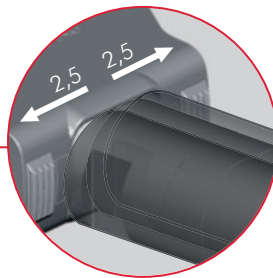
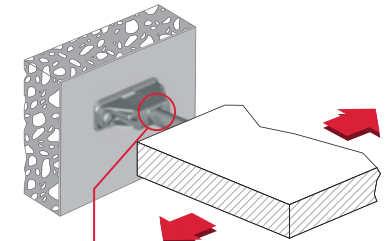

### INCLINATION ADJUSTMENTS

TURN CLOCKWISE THE SUPPORTING PIN WITH A 10 - 12 mm OPEN-ENDED WRENCH TO ADJUST THE SHELF ANGLE FRONT TO BACK ACCORDINGLY

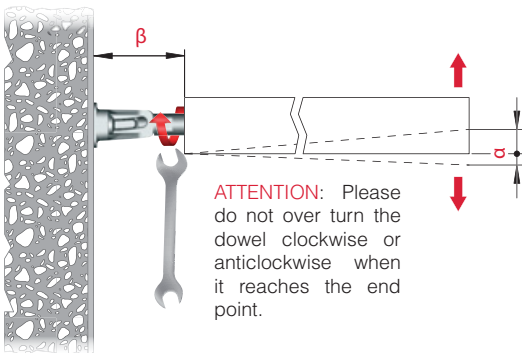

MODEL	β(mm)	α(mm)
TRIADE MINI	approx.45	-6 +13
TRIADE	approx.45	-6 +13
TRIADE MAXI	approx.70	-8 +20
TRIADE XXL	approx.70	-8 +20

SCREW THE LOCKING BOLT TO BLOCK THE PIN

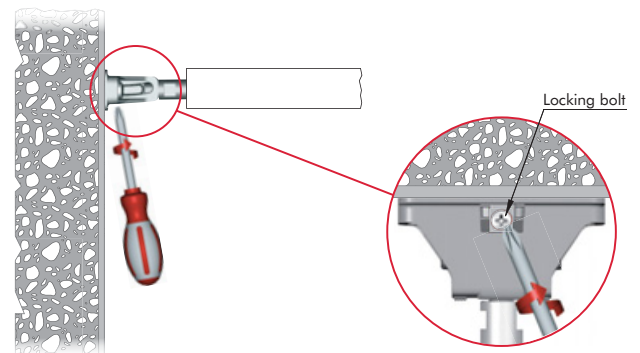

### SHELF INSERTING FOR ALL TRIADE MODELS

PUSH THE SHELF AGAINST THE WALL UNTIL THE END

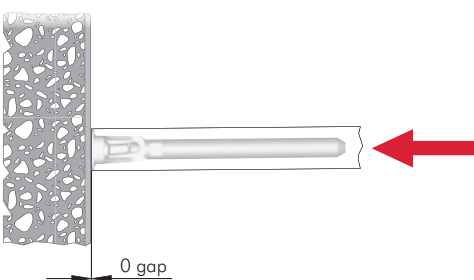



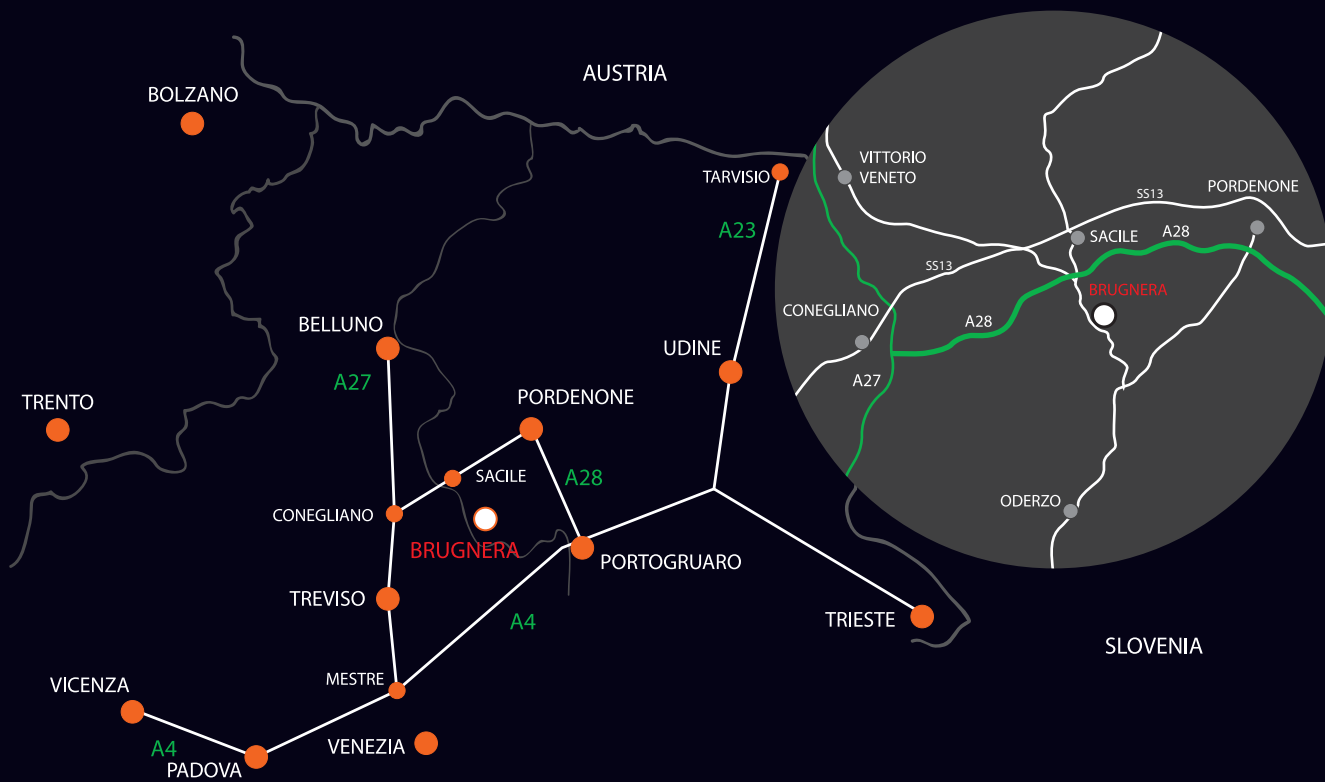

[www.italianaferramenta.com](http://www.italianaferramenta.com)