

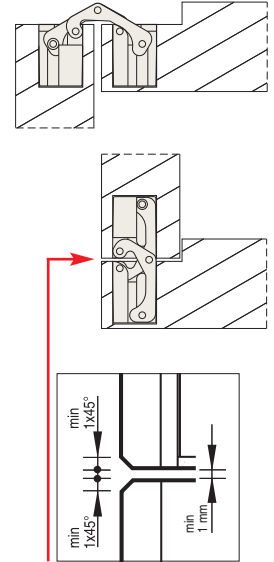

830 96,5x19,6 mm

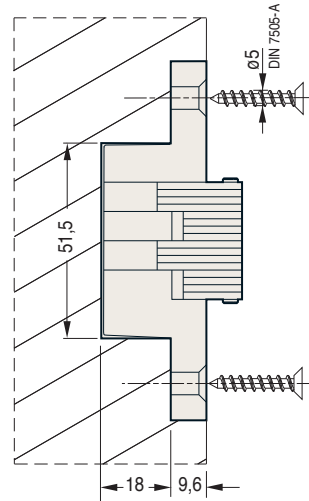

Cod.	Steel and zinc alloy		
CI000830OTT00	brass	180°	20
CI000830NIK00	nickel	180°	20
CI000830BRO00	bronze	180°	20

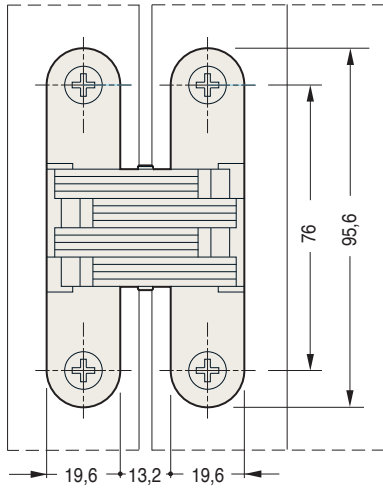

Mortise dimensions

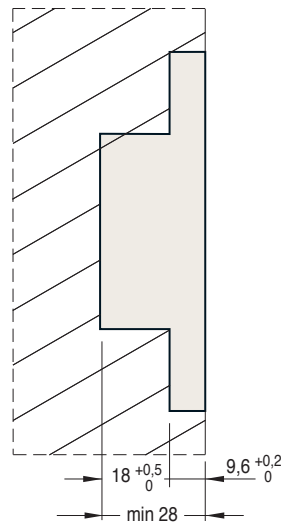
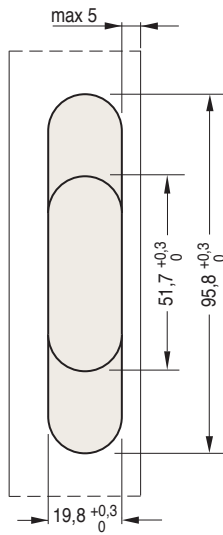

Cross section

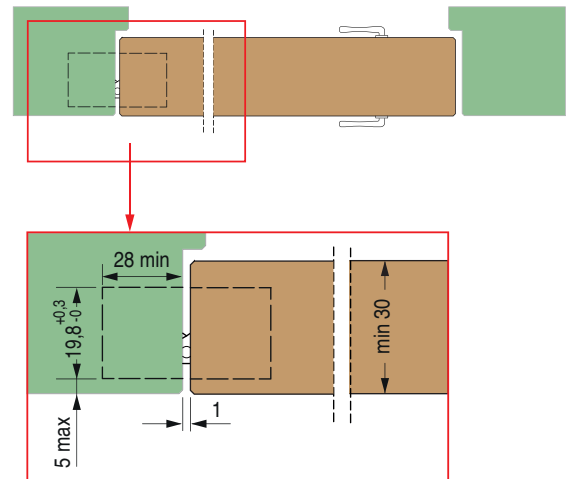



830 96,5x19,6 mm



Load capacity

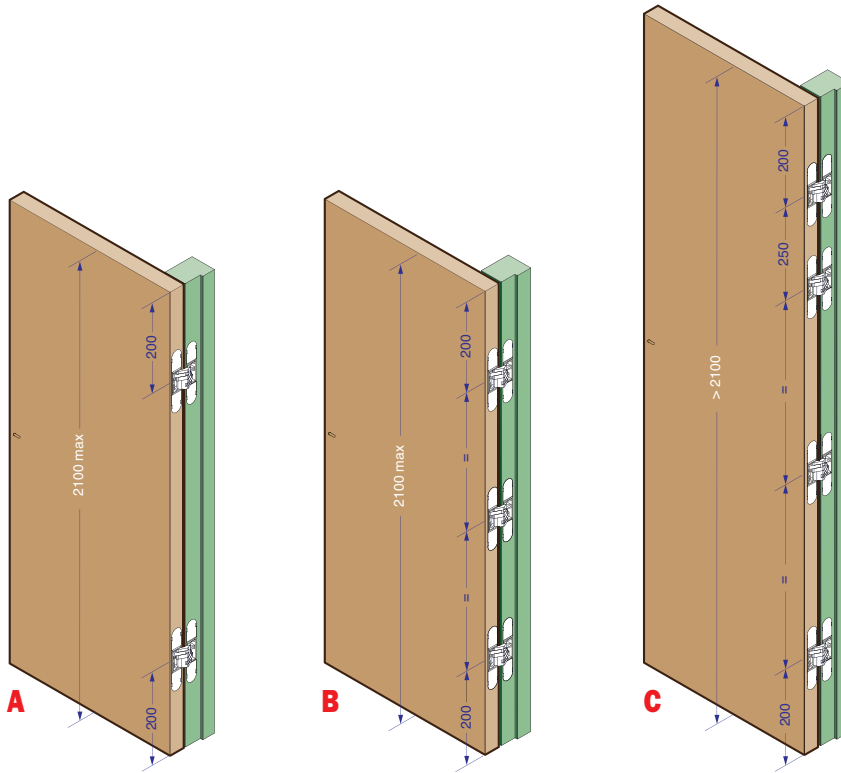

Wings
850 mm wide

- up to 2100 mm high
 - A** - 2 hinges 35 kg
 - B** - 3 hinges 50 kg
- over 2100 mm high
 - C** - 4 hinges 50 kg

Before using a door
closer, contact
our technical office at
ph. +39 031 771316

All hinges must be
adjusted

Lubricate the hinges at least once
a year