

Sistema di apertura per ante **Opening system for furniture applications**

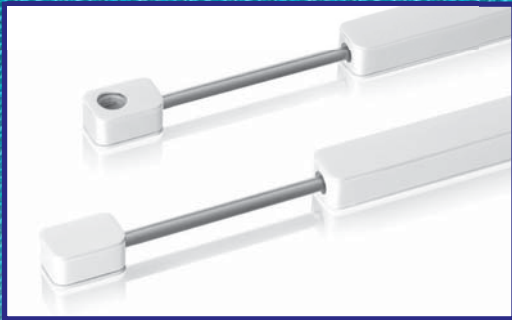

121



Sistema di apertura
per ante

*Opening system for
furniture
applications*

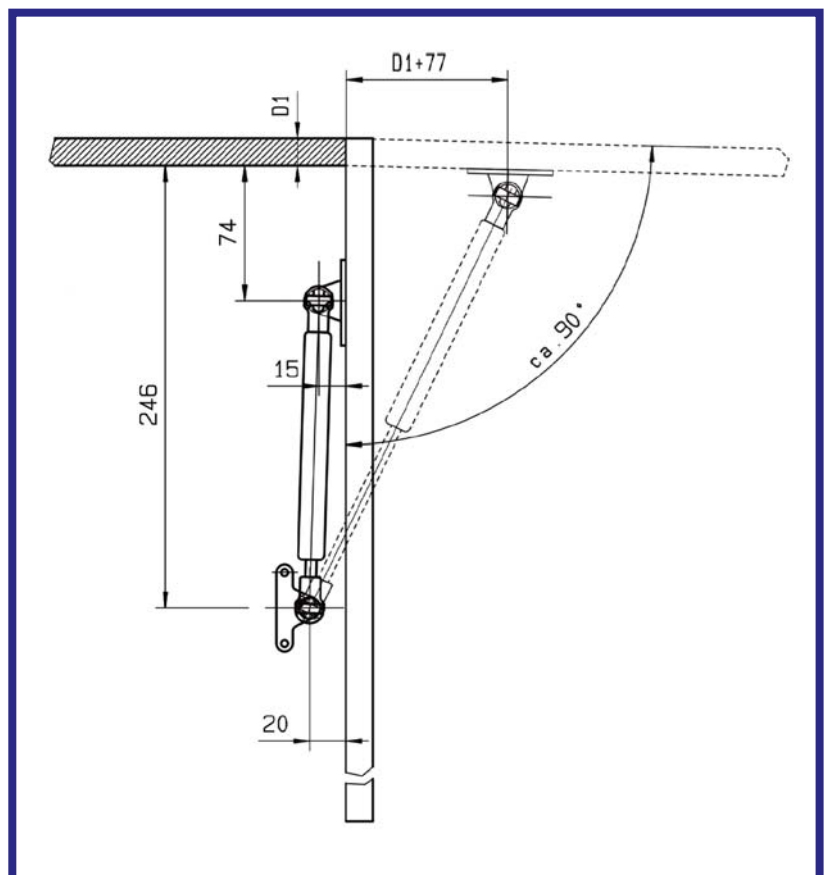

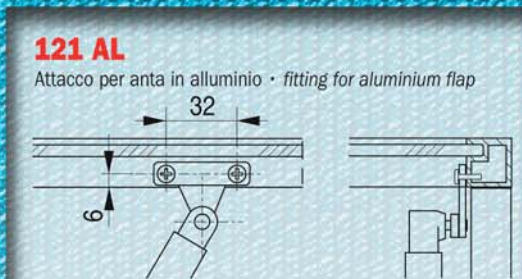
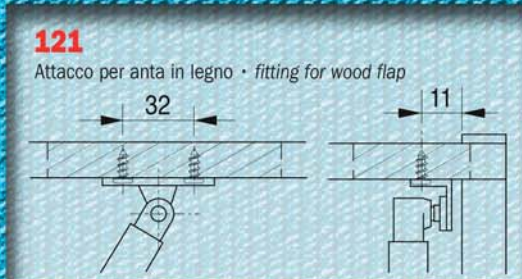
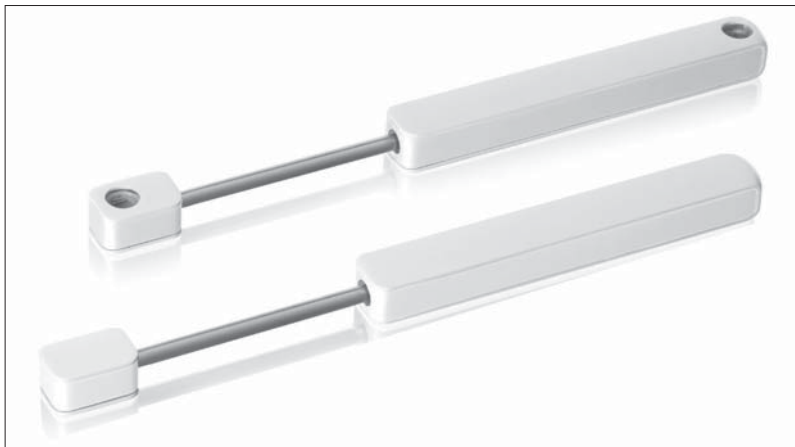

	Cod	Quantity	F ₁ (N)
121	PG0 121 08BIA00	2	80
	PG0 121 10BIA00	2	100
	PG0 121 12BIA00	2	120
121AL	PG0 121 08BIAAL	2	80
	PG0 121 10BIAAL	2	100
	PG0 121 12BIAAL	2	120

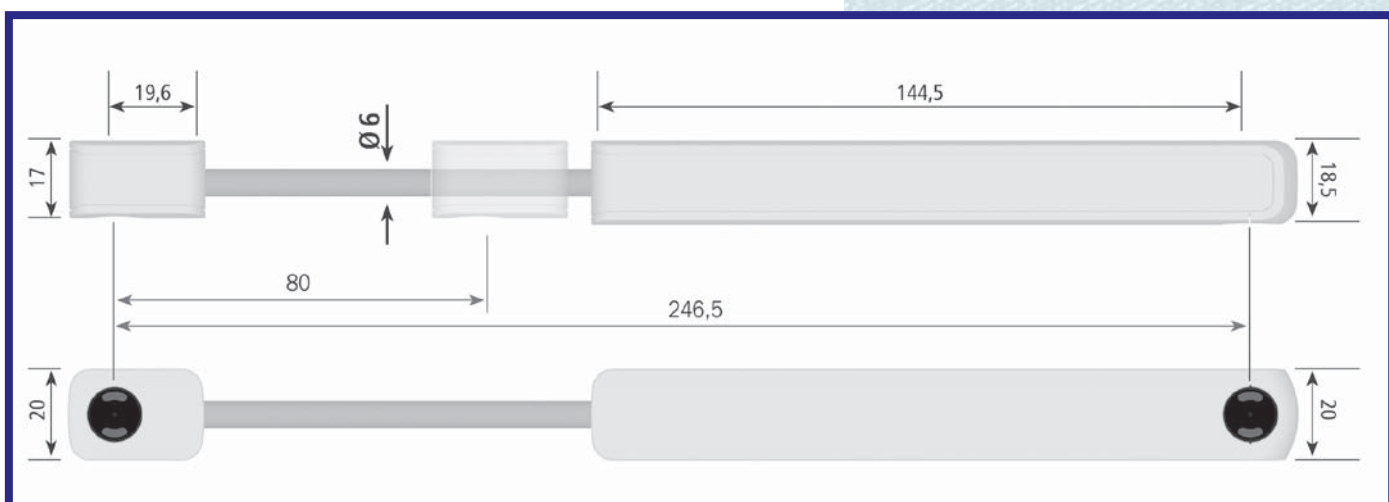
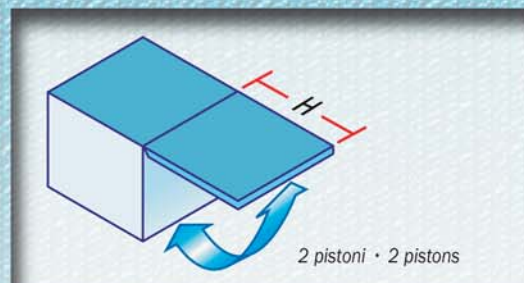
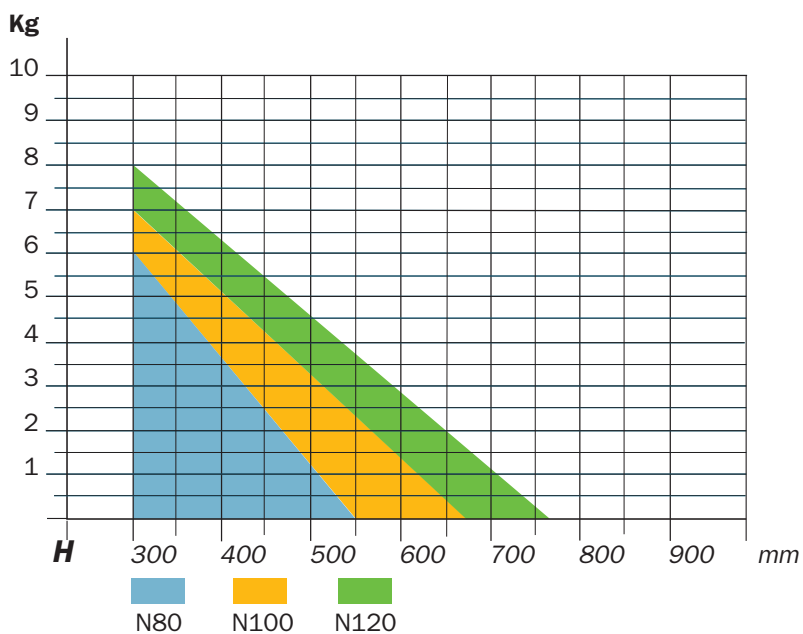



CEAM AMADEO S.P.A.

Via Dante Alighieri, 5 • 22072 Cermenate (Como) Italy
Tel. +39 - 031 77 13 16 • Fax +39 - 031 77 29 11

www.ceamitalia.it
www.cerniereregolabili.it
www.adjustable-hinges.com
e-mail: ceamitalia@ceamitalia.it